

# Operation

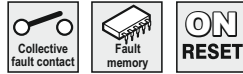

## Starting operation

### After connecting the voltage...

The MAINS LED lights up, the relay is energised (alarm off).

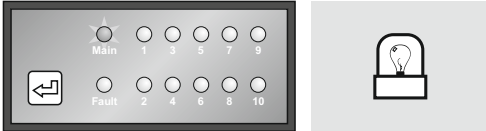

The fault indicator is ready for operation.

## Fault indication

In the event of a fault in a system component:

The FAULT LED and the LED corresponding to the fault input light up, the relay is deactivated (alarm indication)

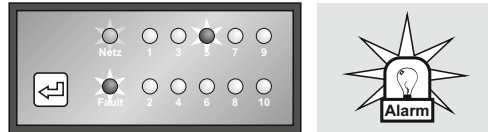

## TEST function

Press Enter key:

As a test, all LEDs light up for as long as the key is pressed.

### If the fault signal cancels itself:

The fault input and FAULT LEDs remain lit, the relay remains deactivated (alarm indication)

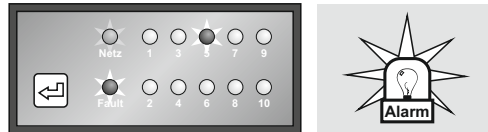

## Loss of voltage

### Following a loss of voltage...

The MAINS LED lights up, the relay is energised (alarm off).

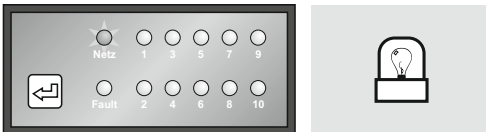

Press Enter key:

The fault input and FAULT LEDs go out, the relay is energised (alarm goes off).

The fault indicator is again ready for operation.

### Fault signal remains:

The fault input and FAULT LEDs remain lit, the relay remains deactivated (alarm indication)

**RESET possible only after the fault has been remedied.**

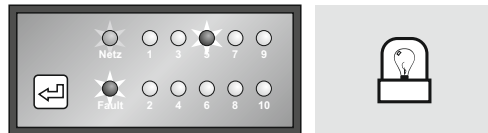

Press Enter key:

The fault input and FAULT LEDs go out, the relay is energised (alarm goes off).

The fault indicator is again ready for operation.



# Operating Instructions

Fault warning systems SM-10q (-L)\* (-5S)\*\*



**This operating instructions contains important technical and safety informations.**

**Please read carefully before installation and before any work on or with the fault warning system!**

The SM-10q series fault indicators are suitable for monitoring small and medium-sized control and regulation systems.

Up to 10 external system components can be simultaneously monitored, easily and transparently. A mains connection LED permanently shows that the fault indicator is operational.

Optocoupler inputs ensure that maximum operating safety is guaranteed when incoming fault signals are transmitted.

\* option -L: input signals are processed LOW-ACTIVELY (wire-break fuse).

\*\* option -5S: fault indication is delayed by the set number of seconds.

**WELBA GmbH**  
Electronic Control Systems  
Gewerbepark Siebenmorgen 6  
D-53547 Breitscheid

**Phone: +49 (0)2638 / 9320-0**  
**Fax: +49 (0)2638 / 9320-20**  
**E-mail: info@welba.de**  
**Net: www.welba.de**



## Safety

The fault warning system may only be installed by an authorized specialist, observing all local safety requirements!

Only specialists must be allowed to access the environment when connected!

The fault warning system contains live components and must not be opened.

The device must not be used if the housing or the connection terminals are damaged.

No liquids must penetrate the housing.

The fault warning system may be exported to the USA with the permission of the manufacturer only.

## Housing installation

The housing is mounted using two lateral screw fittings.



- Fit the rubber seal as shown
- Place the housing through the front opening.
- Attach the lateral screw fittings.
- Tighten the screws.

## Dimensions

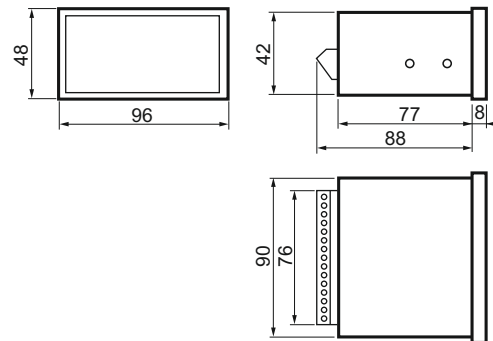

## Technical Data

|                       |                                |
|-----------------------|--------------------------------|
| Operating voltage:    | See key to models              |
| - Voltage A           | 230 V AC, 50/60 Hz             |
| - Voltage B           | 115 V AC, 50/60 Hz             |
| - Voltage F           | 24 V UC                        |
| Display:              | 5 mm LEDs                      |
|                       | - 10 fault input               |
|                       | - 1 mains check                |
|                       | - 1 collective fault           |
| Fault inputs:         | 10 via optocoupler             |
| Relay contact:        | 1 voltage-free two-way-contact |
| Max. switch. current: | 8 AAC 1 / 250 V ~              |
| Protection:           | IP 64 (housing front)          |
| Connection:           | Screw terminals                |
| Ambient temperature:  | 0°C to 50°C                    |

## Intended use

Type SM-10q fault indicators are suitable only for monitoring external appliances. They must not be used for any other applications.

It is not allowed to install this device in explosive environment.



The fault warning system SM-10q fulfills EC requirements for electromagnetic compatibility (EMC).

The safety components meet VDE regulations.

## Installation

It is essential not to install the device under the following conditions:

- severe jolting or vibration
- permanent contact with water
- relative humidity of more than 75%
- sharply fluctuating temperatures (condensation)
- operation in an aggressive atmosphere (ammonia or sulphur fumes) - risk of oxidation
- operation in the immediate vicinity of radio transmitters with high levels of spurious radiation.

## Electrical connections

Before connecting, ensure that the mains voltage is the same as indicated on the device's type plate.

An incorrect operation voltage can destroy the device and the additional components as well!

It is only allowed to switch on the device when all components are finally connected to the device!

If the external components use more than >8AAC1 (or high drain of the relay contacts) it is strictly important to use a contactor with a RC circuit!

Take care of technical data!

Electrical connection should be carried out as follows:

- External appliances to be monitored should be connected in accordance with the connection diagram. The potential from connection A1 should be applied to all fault inputs.
- Connect the alarm to the collective fault contact. (The circuit diagram shows the contact position in de-energised status.)

Observe the following tips:

- Use cable bushes.
- Make sure that cables cannot chafe.

Information on option -L:

Input signals are processed LOW-ACTIVELY, i.e. in operating status the fault inputs must be under voltage. Faults are then indicated if voltage is lost.

Information on option -5S:

Incoming faults (regardless of whether HIGH- or LOW-ACTIVE) are indicated with a delay corresponding to the set number of seconds.

Faults of a short duration are ignored.

## Connection diagram

You will find the correct circuit diagram for your fault warning system on the back of the housing, above the connection terminals.

